



TRANE®

TCONT800 Series Touch Screen Programmable Comfort Control

OWNER'S GUIDE



22-5207-04



US Pat. #6595430, D509151 and Other Patents Pending

69-1791-05

Contents

Features	3
Home Screen	4
Programming Your Heating and Cooling Schedule	6
Operating Your Comfort Control	16
Replacing Your Batteries	23
Cleaning Your Comfort Control Screen	28
Reading Your Outdoor Temperature (Select Models).....	29
Reading Your Remote Indoor Temperature (Select Models).....	30
Reading Your Inside Humidity Level (Select Models)	34
Controlling Your Inside Dehumidification Setting (Select Models)	35
Advanced Settings	40
Frequently Asked Questions and Answers	48
Limited Five-Year Warranty	49
Customer Assistance	51

IMPORTANT

The comfort control has a touch screen interface. Touch keys appear, as necessary, to complete tasks. Always press the keys with your fingertips. Sharp instruments like a pen or pencil point can damage the comfort control.

This thermostat contains a Lithium battery which may contain Perchlorate material. Due to State Law in California, the following statement is required:

Perchlorate Material—special handling may apply,
See www.dtsc.ca.gov/hazardouswaste/perchlorate

Features

- **Large, Clear Display with Backlighting**—current temperature, set temperature and time are easy to read and all are displayed on the home screen.
- **Menu Driven Programming**—Guides you through the scheduling process, showing only necessary information and choices on each screen.
- **Ability to Select Multiple Days**—allows you to easily customize the comfort control for your unique schedule.
- **Real-Time Clock**—keeps time during power failure; automatically updates for daylight savings.
- **Armchair Programming**—allows you to remove comfort control from wall to set the schedule (with three AAA batteries installed).
- **Precise Temperature Control (+/- 1° F)**—reliable, consistent comfort.
- **Multiple HOLD options**—allows you to modify schedule indefinitely or for a specific time.
- **Change Reminders**—reminds you to service or replace the air filter, humidifier pad or batteries.
- **Programmable Fan**—increases air quality when combined with a whole-house air cleaner.
- **Outdoor Temperature Indication (Select Models)**—shows current outdoor temperature on the display to help you plan outdoor activities.

NOTE: The home screen may differ slightly, depending on the heating and/or cooling system you have and the comfort control settings for your system type.

Home Screen

Key Description

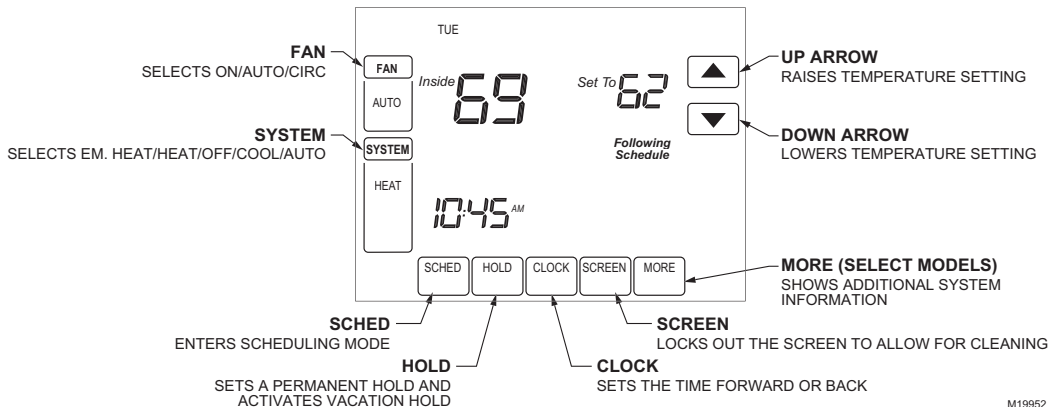

M19952

Display Description

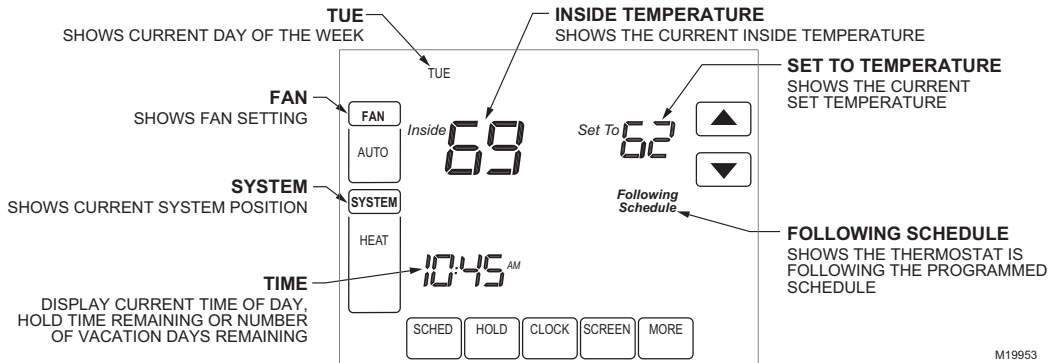

M19953

Programming Your Heating and Cooling Schedule

Your comfort control can control up to four different schedule periods per day:

Wake—Period when you awaken and want your home at a comfortable temperature.

Leave—Period when you are away from home and want an energy-saving temperature.

Return—Period when you return home and want your home back to a comfortable temperature.

Sleep—Period when you are asleep and want an energy-saving temperature.

NOTE: Schedule times are in 15-minute intervals.

Preprogrammed Energy Star Settings

Table 1 shows default program settings. Visit the Energy Star web site at www.energystar.gov for additional education and resources on programmable comfort controls.

Table 1. Energy Star Default Program Settings.

Schedule Period	Time	Setpoints		Fan Setting
		Heat	Cool	
Wake	6:00AM	70°F (21°C)	78°F (25.5°C)	Auto
Leave	8:00AM	62°F (16.5°C)	85°F (29.5°C)	Auto
Return	6:00PM	70°F (21°C)	78°F (25.5°C)	Auto
Sleep	10:00PM	62°F (16.5°C)	82°F (2°C)	Auto

Editing Schedule

1. Press Sched key.

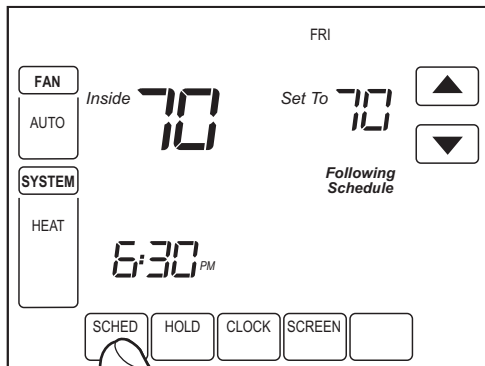

M22445

2. Press Edit key.

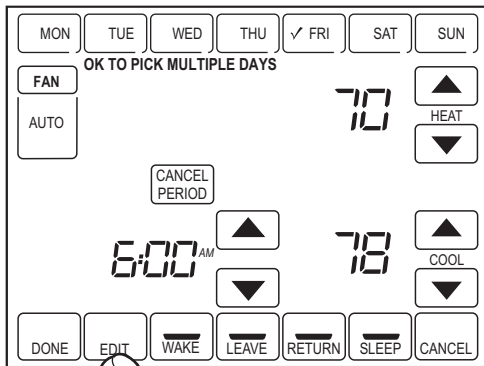

M22553

3. It is OK to pick multiple days. Select any combination of days to edit. These days are scheduled with the same times and temperatures. Check marks appear next to days selected.

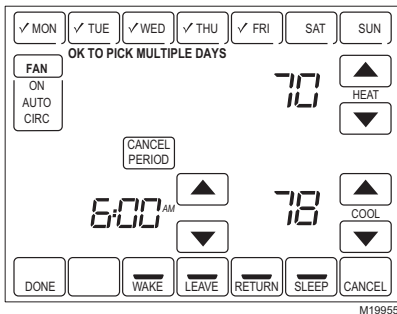

4. Press Wake key. Once pressed, Wake flashes to show it is selected.
5. Press Up and Down keys to modify time and heat and cool temperatures from this screen.

NOTE: The Fan setting can be programmed for On, Auto, or Circ for each period selected. See Fan Schedule section for more information.

6. Press Leave key and repeat step 5.
7. Press Return key and repeat step 5.
8. Press Sleep key and repeat step 5.

9. When complete, press Done key. “Saving Changes” appears on the screen to indicate changes are being saved to the day(s) modified.

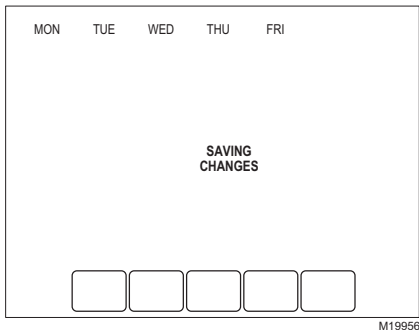

NOTE: To set a Program Schedule for the remaining days of the week, repeat steps 1-9. Example: If Mon - Fri was selected first, go back and repeat steps 1-9 for Sat and Sun.

10. To exit schedule without saving changes, press Cancel key at any time.

Canceling a Schedule Period

NOTE: You may want to cancel a period to match your lifestyle; for example, if someone is always home during the day on Tuesday, you can cancel the Leave and Return periods (the comfort control would then control to the Wake temperature until the Sleep period).

1. Press Sched key.
2. Press Edit key.
3. Select the Day(s) of the week desired.
4. Press schedule period you want to cancel (Wake, Leave, Return or Sleep). Once selected, the period flashes.

5. Press Cancel Period key.

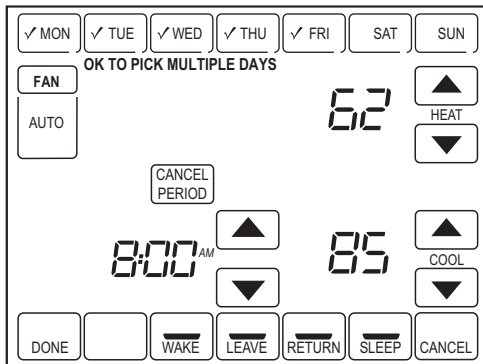

M22446

NOTE: Note that the time, temperature(s) and fan setting disappear. The bar above the selected period is removed, indicating the scheduled period was cancelled. To reinstate a schedule period, press arrow keys to set desired time and temperatures.

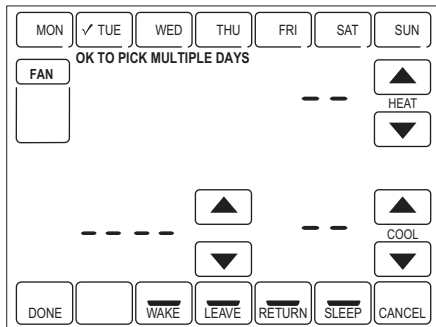

M19957

6. Press Done key.

Setting Time

1. Press Clock.
2. Use arrows to set current time.

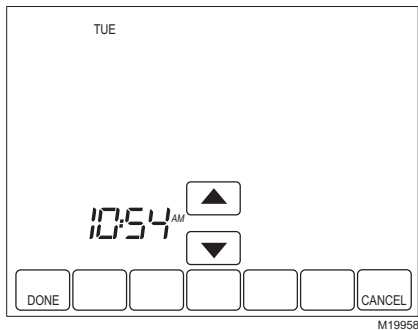

3. Press Done key.

IMPORTANT

The current day of the week should already be set correctly. If not, see advanced settings to set the day.

Operating Your Comfort Control

Setting Fan and System Keys

SETTING FAN KEY

The Fan key selections vary based on your heating and/or cooling system type.

On — fan runs continuously. Use this setting for improved air circulation or for more efficient central air cleaning.

Auto — fan follows fan program schedule. See Fan Schedule section for more information.

Circ — fan runs randomly approximately 35% of time. Use this setting for improved air circulation or for more efficient central air cleaning when you do not want the fan running continuously.

SETTING SYSTEM KEY

The System key selections vary based on your heating and/or cooling system type.

Heat — controls your heating system.

Off — both heating and cooling systems are off.

Cool — controls your cooling system.

Auto (when enabled) — controls both your heating and cooling system based on temperature.

Em. Heat (heat pump systems only) — controls emergency heat and auxiliary heat, if needed. Heat pump is not operational.

Setting Temperature Overrides

Your comfort control has three temperature override options: Hold Temperature Until, Permanent Hold and Vacation Hold.

HOLD TEMPERATURE UNTIL (TEMPORARY HOLD)

Holds temperature temporarily until the next scheduled period time or until the time the user sets.

1. Press Up or Down arrow next to the temperature you want to adjust. “Hold Temperature Until” time appears on the screen. The Hold Temperature Until time defaults to the start time of the next scheduled period.

NOTE: The Time Up and Down arrows are shown for approximately seven seconds. Pressing on the screen time (where the Hold Temperature Until time is shown) allows the arrows to reappear.

2. Press Up or Down arrow next to the Time key to set desired time for the comfort control to resume schedule.

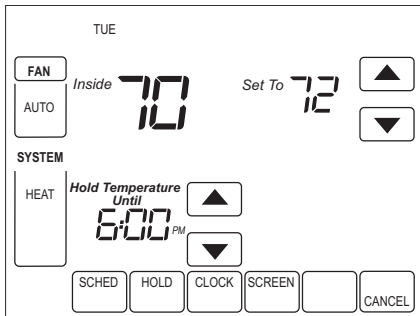

M19959

3. Press the Cancel or Sched key to cancel “Hold Temperature Until” and resume schedule.

NOTE: Once “Hold Temperature Until” time is reached, the comfort control shows “Following Schedule” on the screen to indicate that “Temporary Hold” has ended.

PERMANENT HOLD

Permanent Hold changes the temperature setting until Permanent Hold is cancelled.

1. Press Hold key. “Permanent Hold” appears on the screen.
2. Press Up or Down arrow next to the temperature you want to set during “Hold.”

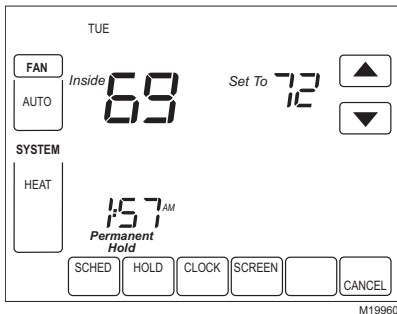

3. Press Cancel key to cancel “Permanent Hold” and resume the schedule.

VACATION HOLD

Changes temperature setting for a designated number of days.

1. Press the Up and Down arrow keys to set the desired temperature while away on vacation. Notice that “Hold Temperature Until” time is shown on the screen. (This is the time the Vacation Hold override expires after the number of days ends.)
2. Press Hold key twice. Screen shows “Hold Temperature Until” one day.
3. Press Up and Down arrow keys to change the number of Days you desire comfort control to override the schedule.

NOTE: Days Up and Down arrows appear for approximately seven seconds. Pressing just below Hold Temperature Until on the screen allows the Days Up and Down arrows to reappear.

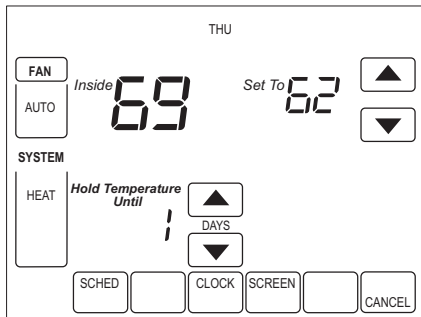

M19961

4. To cancel the Vacation Hold override early, press the Cancel key.

NOTE: When the number of days of Vacation Hold expires, the screen shows “Following Schedule” to indicate that Vacation Hold has ended.

Fan Schedule

Press Fan key while in the Scheduling Screen to program the System Fan. Choices available from the Scheduling Screen:

Auto (default position)—fan runs with equipment. Programmable for all schedule periods (Wake, Leave, Return and Sleep).

On—fan runs continuously (programmable for all schedule periods).

Circ—fan runs randomly for approximately 35% of schedule period (programmable for all schedule periods).

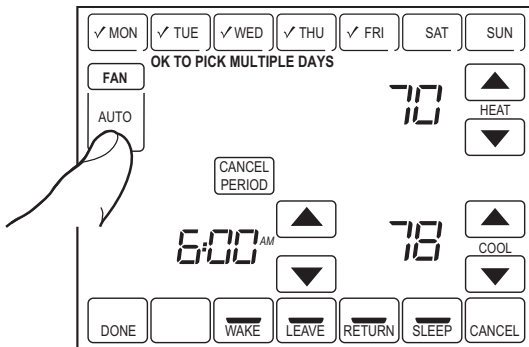

M22447

Fan Status Displayed on Home Screen

If the Fan program is scheduled, Auto is shown and any programmable mode that is set; for example, if during Wake period, Fan is set to Auto, only Auto is shown in the Fan area. However, if during the Wake period, fan is scheduled to On, both Auto and On are shown. Auto indicates fan is running its schedule; On indicates Fan schedule is set to On.

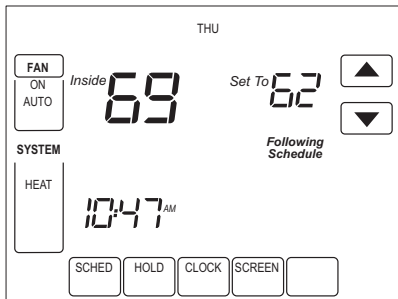

M19962

Manual Override of Fan Schedule

Auto—fan is automatically following the Fan schedule (choices are Auto, On or Circulate).

On—overrides Fan schedule. Fan is continuously On.

Circ—overrides Fan schedule. Fan circulates randomly for approximately 35% of time until the Auto position is selected.

Replacing Your Batteries

1. When the LO Battery indicator is flashing, replace the batteries promptly with three fresh AAA alkaline batteries

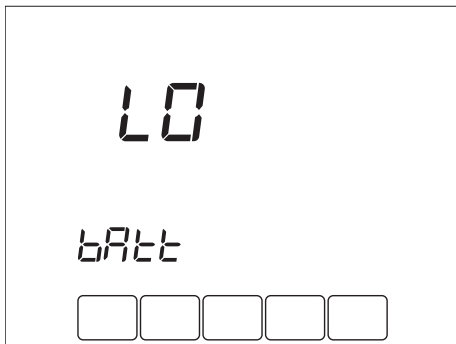

M19963

2. Remove comfort control from the wallplate by pulling straight out.

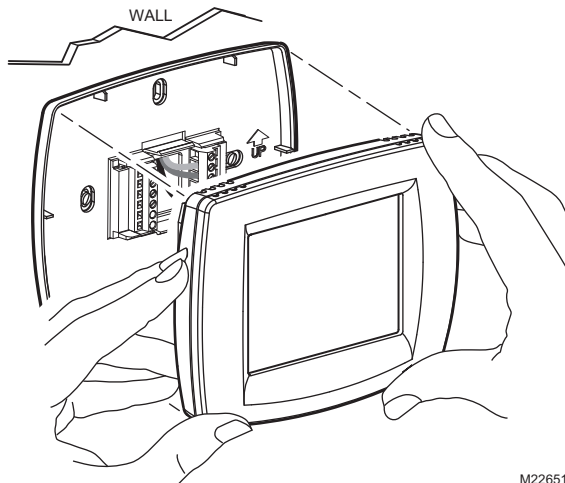

M22651

3. Remove the old batteries and insert three fresh AAA alkaline batteries, as marked on the comfort control.

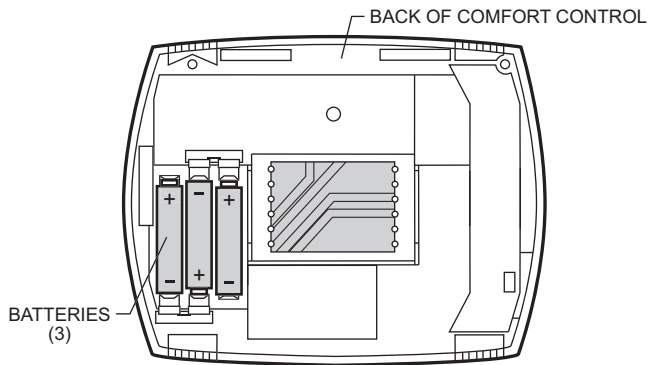

M22212

4. Align the screw blocks with the pins on the back of the comfort control.

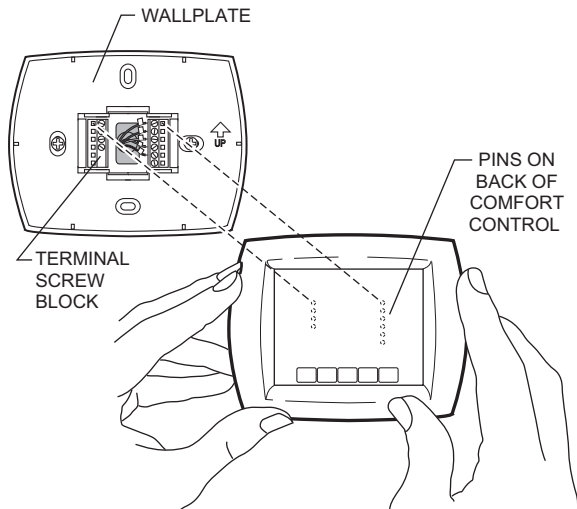

M22652

5. Push the comfort control straight onto the wallplate until it snaps into place.

Battery Tips

1. Replace the batteries as soon as LO Batt flashes in the display. The LO Battery indicator flashes in the display one month before the batteries run down completely.
2. Always use fresh AAA alkaline batteries. Non-alkaline batteries do not last as long and can leak, causing comfort control damage.

Battery Power (Optional)

The comfort control is designed to be programmed while relaxing in your favorite chair. Install the three AAA batteries on the back of the control and you are ready to go. When you have completed programming the control, remove the batteries or simply leave them in place.

Cleaning Your Comfort Control Screen

The comfort control has a touch screen interaction. Follow these steps to clean the screen without making comfort control changes:

1. Press the Screen key. Comfort control locks out all touch keys for 30 seconds for cleaning.

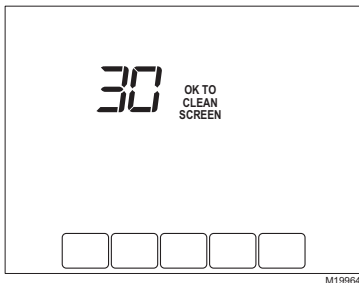

2. Use damp cloth slightly moistened with water and mild dishwasher detergent to clean the screen.
3. Repeat the above steps, as necessary.

IMPORTANT

Do not spray any type of liquid directly on the comfort control itself.

4. Press the Done key to return to the Home Screen and normal operation.

Reading Your Outdoor Temperature (Select Models)

If your comfort control has an outdoor sensor, the comfort control displays the outdoor temperature.

VIEW OUTSIDE TEMPERATURE (SELECT MODELS)

The outside temperature is located in the lower right corner of the Home Screen. If it is not on the Home Screen, view the outside temperature by pressing the More key until the outside temperature shows.

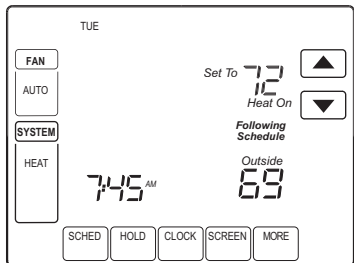

M19971

Reading Your Remote Indoor Temperature (Select Models)

If your comfort control has a remote indoor temperature sensor installed, the comfort control displays the inside temperature on the screen from the remote sensor(s). (Then the comfort control internal temperature sensor is not used.)

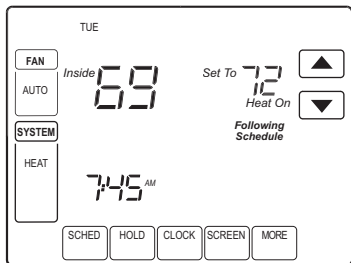

M19974

ONE REMOTE INDOOR SENSOR INSTALLED (SELECT MODELS)

If one remote indoor temperature sensor is used, the screen showing the *Inside* temperature reading shows the temperature at the indoor remote sensor location.

MULTIPLE REMOTE INDOOR SENSORS INSTALLED (SELECT MODELS)

If more than one remote indoor sensor is used, the screen showing the *Inside* temperature reading shows the average of all the remote indoor sensors.

Reminder Timers (Select Models)

These reminders notify you when to change your furnace filter or humidifier pad. When the time you set expires, the comfort control flashes “Change” and then “Filter” or “Change” and “Humidifier Pad” until you reset the timer.

Resetting Expired Timers

When a Timer expires, a Reset key appears on the Home Screen. Press Reset key to reset the Timer. Notice that the “Change” reminder disappears from the comfort control screen. If more than one Timer expires at the same time, press the Reset key to reset all expired Timers.

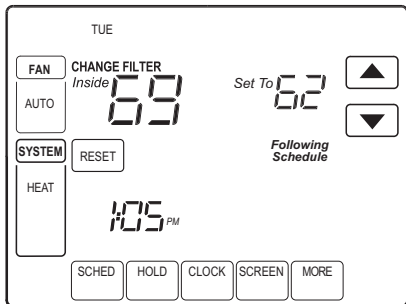

M19975

View or Reset Timer Settings Before They Expire

1. Press More key until the Timer you want to modify appears on the screen.
2. Press Edit key to change the Timer reload value. Use Up and Down arrow keys to change the number of Run Time Days. See Advanced Settings, steps 8 through 10, for approximate calendar days.
3. Press the Done key to go back to viewing the selected timer.
4. Press Reset key to reset the timer to the timer reload value. (This is the Advanced setting you set or the reload value you selected in step 2.)
5. Press Done or Cancel key to return to the Home Screen.

Screen Locked

You can fully or partially lock out the keys on the touch screen interface. See Advanced Settings for information on turning these features on or off. If the comfort control shows “Screen Locked,” your comfort control screen is either fully or partially locked.

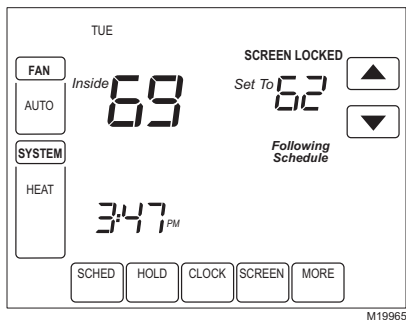

Partially Locked Screen

When partially locked, the screen indicates Screen Locked for 5 to 7 seconds whenever the user attempts to press a key that is locked. Pressing a locked key while Screen Locked is shown flashes Screen Locked on the screen. Pressing an unlocked key while Screen Locked is active removes the screen lock.

In this mode, all keys are locked except the Temperature Up and Down arrow keys:

- User can change temperature up or down but cannot change schedule settings.
- Temporary temperature change lasts until next scheduled period and that time shows on screen.
- To cancel temperature override and begin following schedule, press Cancel key.
- To unlock screen, see Advanced Settings section.

Fully Locked Screen

In this mode, all keys are locked and not functional. To unlock screen, see Advanced Settings section. The screen continuously displays “Screen Locked.”

Reading Your Inside Humidity Level (Select Models)

Select models can sense the humidity level in the home. If your model has this feature, the humidity level in the home is shown in the lower right corner of the Home Screen.

NOTE: If the comfort control has the optional outdoor temperature sensor (select models), the indoor humidity level is displayed by pressing the More key.

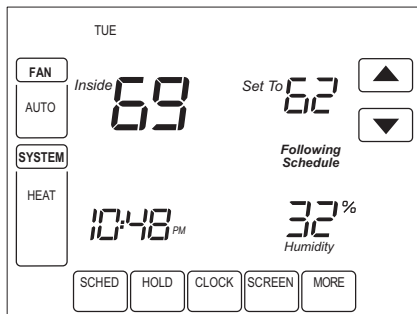

M19966

Controlling Your Inside Dehumidification Setting (Select Models)

Select models read the inside humidity level and set a desired humidity level to help control dehumidification in the home.

NOTE: See step 8 on page 44.

1. Press the More key until the inside humidity percent and dehumidification setpoint are shown.

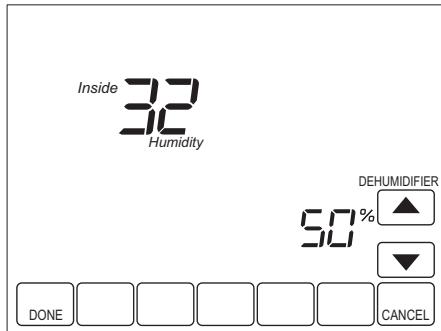

M19967

2. Use Up and Down arrow keys, located to the right of the dehumidifier setpoint, to set your desired humidity level (select models) for dehumidification in the summer.
3. Press Done key to save your changes and return to the Home Screen.
4. Press Cancel key to return to Home Screen without saving any changes.

Dehumidification Control (Select Models)

If your comfort control has dehumidification control and you set a dehumidification setpoint, the comfort control attempts to control to this dehumidification setpoint by turning on the air conditioner. In extremely high humidity conditions, comfort control keeps the air conditioner running for up to 3°F below your temperature setpoint. It does this when trying to achieve your desired humidity setpoint and balance that with your temperature setpoint.

Temperature Recovery

Your comfort control comes with a feature called Adaptive Intelligent Recovery™, which eliminates all guesswork when setting your schedule. How long does it take the furnace to warm your house in the morning before you get out of bed or how long does it take the air conditioner to cool your house in the afternoon before you return from work? No problem. The comfort control determines that for you.

Simply set your program schedule to the time you want the house to be at your comfort temperature. The comfort control then turns on the heating or cooling at just the right time to have your home reach your scheduled temperature at your scheduled time.

For example—you get out of bed at 6:00 AM and want the temperature to be 70°F. Set the Wake period for 6:00 AM and 70°F. The comfort control then turns on the heat before 6:00 AM to raise the temperature to 70°F by 6:00 AM.

The comfort control alerts you that the heating or cooling system is coming on before a scheduled time by showing “Recovery” on the screen.

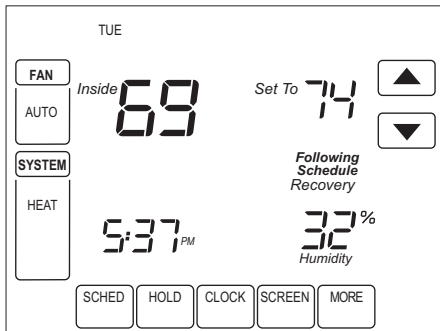

M19968

IMPORTANT

It takes about a week for the comfort control to adjust to local weather, your schedule, the construction of your home and your heating and/or cooling system. Your comfort control learns from experience. Each day it checks how closely it reached the recovery time and adjusts the next day's recovery start time accordingly.

Advanced Heat Pump Features (Select Models)

If you have a heat pump heating system, your comfort control can use some special features when used with an Outdoor Temperature Sensor, such as compressor and/or backup heat lockout based on outside temperature. For example, if your backup heat does not turn on above a designated outside temperature, your system uses an advanced heat pump feature.

Setting the Calendar

This comfort control is designed to automatically keep current time and day in memory for up to ten years, under normal use, once the calendar is set. There are two ways to set the calendar for this comfort control:

SETTING CALENDAR AFTER COMFORT CONTROL IS ALREADY FUNCTIONING

See steps 1 through 4, in the Advanced Settings section, to set year, month and day.

SETTING CALENDAR WHEN COMFORT CONTROL IS FIRST POWERED

When this comfort control is first powered, the display is ready to set the calendar.

SET CURRENT DAY
SET MONTH

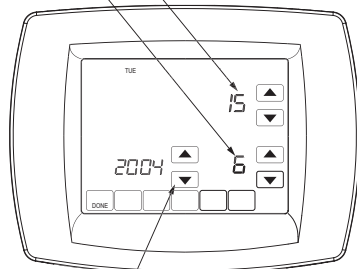

USE ARROWS TO SET YEAR AND TIME

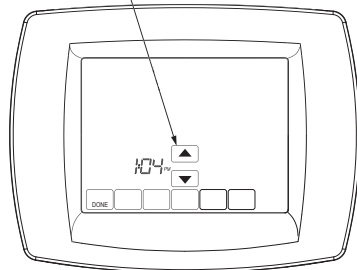

M22645

Advanced Settings

Your comfort control has many advanced settings to match your heating and cooling system. But you can change these settings to match your lifestyle:

1. From the Home Screen, press the System key. Five blank touch keys show on the bottom of the screen between the Done and Cancel keys.
2. Press and hold the center blank key for approximately five seconds, until the screen changes.

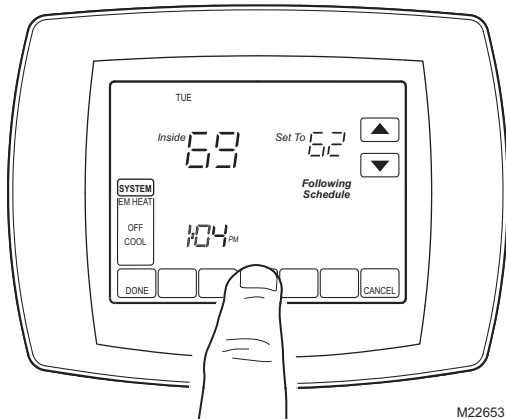

M22653

3. Release the center key when the display on your comfort control matches the display below.

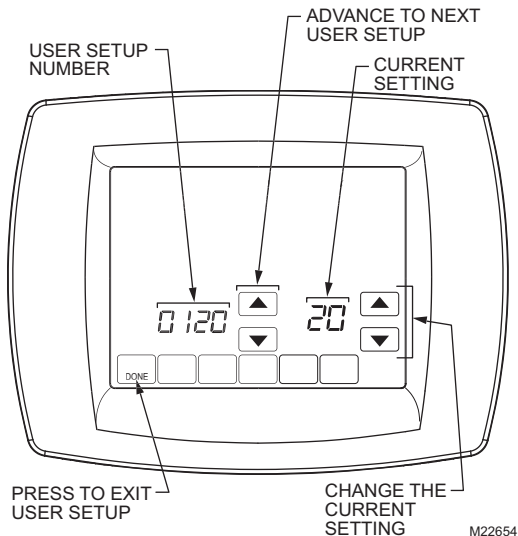

Step 1. User Setup Number 0120: First Two Digits of Current Calendar Year.

To change current setting, press the Up or Down arrow key to the right of the two-digit number in the lower right corner of the screen. Options:

20 — equals years **20**xx.

21 — equals years **21**xx.

To Change to the next Setup Number, press the Up arrow key to the right of 0120. To go back to the previous Setup Number, press the Down arrow key.

Step 2. User Setup Number 0130: Last Two Digits of Current Calendar Year.

To change Options, press the Up or Down arrow key to the right of the two-digit number in the lower right corner of the screen. Options:

01 through 99 — equals years **2001** through **2099**.

To Change to the next Setup Number, press the Up arrow key to the right of 0130. To go back to the previous Setup Number, press the Down arrow key.

Step 3. User Setup Number 0140: Current Calendar Month.

To change Options, press the Up or Down arrow key to the right of number in lower right corner of the screen. Options:

1 through 12 — equals January through December.

To Change to the next Setup Number, press the Up arrow key to the right of 0140. To go back to the previous Setup Number, press the Down arrow key.

Step 4. User Setup Number 0150: Current Calendar Date.

To change Options, press the Up or Down arrow key to the right of the number in the lower right corner of the screen. Options: 1 through 31 — equals 1st of a month to 31st of a month.

To Change to the next Setup Number, press the Up arrow key to the right of 0150. To go back to the previous Setup Number, press the Down arrow key.

Step 5. User Setup Number 0160: Schedule Options.

To change Options, press the Up or Down arrow key to the right of the number in the lower right corner of the screen. Options:

0 — nonprogrammable. Comfort control is nonprogrammable.

4 — programmable. Comfort control is fully programmable, allowing all 7 days to be programmed.

To Change to the next Setup Number, press the Up arrow key to the right of 0160. To go back to the previous Setup Number, press the Down arrow key.

Step 6. User Setup Number 0320: Display Temperature Shown in °F or °C.

To change Options, press the Up or Down arrow key to the right of the number in the lower right corner of the screen. Options:

0 — Fahrenheit.

1 — Celsius.

To Change to the next Setup Number, press the Up arrow key to the right of 0320. To go back to the previous Setup Number, press the Down arrow key.

Step 7. User Setup Number 0330: Daylight Savings On or Off.

To change Options, press the Up or Down arrow key to the right of the number in the lower right corner of the screen. Options:

- 0 — Off: No adjustment for Daylight Savings in Fall and Spring.
- 1 — On: Time is automatically adjusted for Daylight Savings in Fall and Spring. (Use through 2006, and for areas that do not use the new 2007 Daylight Savings Time calendar.)
- 2 — On: Time is automatically adjusted for Daylight Savings in Fall and Spring. (Use 2007 and beyond, for areas that use the new 2007 Daylight Savings Time calendar.)

To Change to the next Setup Number, press the Up arrow key to the right of 0330. To go back to the previous Setup Number, press the Down arrow key.

Step 8. User Setup Number 0380: Dehumidification Control On or Off (Select Models).

To change Options, press the Up or Down arrow key to the right of the number in the lower right corner of the screen. Options:

- 0—Off: No Dehumidification Control.
- 1—On: Comfort Control will run air conditioner up to 3°F below the temperature setting when trying to achieve your desired humidity setpoint and balance that with your temperature setpoint.

NOTE: To adjust dehumidification setpoint, see page 35.

Step 9. User Setup Number 0500: Furnace Air Filter Timer.

To change Options, press the Up or Down arrow key to the right of the number in the lower right corner of the screen. Options:

- 0 — Off. Furnace filter timer is off.
- 1 — 10 fan run time days (about one month).
- 2 — 30 fan run time days (about three months).
- 3 — 60 fan run time days (about six months).
- 4 — 90 fan run time days (about nine months).
- 5 — 120 fan run time days (about one year).
- 6 — 365 fan run time days (about three years).

To Change to the next Setup Number, press the Up arrow key to the right of 0500. To go back to the previous Setup Number, press the Down arrow key.

Step 10. User Setup Number 0510: Humidifier Pad Timer.

To change Options, press the Up or Down arrow key to the right of the number in lower right corner of the screen. Options:

- 0 — Off. Humidifier pad timer is off.
- 1 — 3 months.
- 2 — 6 months.
- 3 — 12 months.

To Change to the next Setup Number, press the Up arrow key to the right of 0510. To go back to the previous Setup Number, press the Down arrow key.

Step 11. User Setup Number 0540: Number of Schedule Periods Available to Program.

To change Options, press the Up or Down arrow key to the right of the number in the lower right corner of screen. Options:

2 — two program periods available (Wake and Sleep).

4 — four program periods available (Wake, Leave, Return and Sleep).

To Change to the next Setup Number, press the Up arrow key to the right of 0540. To go back to the previous Setup Number, press the Down arrow key.

Step 12. User Setup Number 0640: Time Format.

To change Options, press the Up or Down arrow key to the right of the number in the lower right corner of the screen. Options:

12 — 12-hour clock.

24 — 24-hour clock.

To Change to the next Setup Number, press the Up arrow key to the right of 0640. To go back to the previous Setup Number, press the Down arrow key.

Step 13. User Setup Number 0670: Screen Lockout Function.

To change Options, press the Up or Down arrow key to the right of the number in the lower right corner of the screen. Options:

0 — All keys are available. Screen is unlocked.

1 — Screen is partially locked. All key functions are locked except the Temperature Up and Down keys and the Cancel key. Enter Advanced Setup to unlock the screen.

2 — Screen is fully locked. Enter Advanced Settings to unlock the screen.

Step 14. Exit User Setup

Press the Done key to exit Advanced Settings and return to the Home Screen.

Frequently Asked Questions and Answers

Q: Some or all keys on the display do not work; why?

A: Comfort control screen is locked. See Advanced Setting section to unlock keys on the screen.

Q: Comfort control is asking for heating or cooling to come on (screen shows “Heat On” or “Cool On” in display) but there is no heating or cooling running.

A: Call your local heating and/or cooling contractor to check your heating and/or cooling system.

Q: Under the Fan on the screen, Auto and On or Auto and Circ are shown. What does this mean?

A: The Fan is programmed for either On or Circulate. See the Fan Schedule section for more information.

Q: Why doesn't the comfort control respond when I touch the keys?

A: Check to determine if the screen is in the Locked or Clean mode. See Screen Locked or Cleaning Comfort Control Screen sections.

LIMITED WARRANTY LOW VOLTAGE ROOM COMFORT CONTROLS (PARTS ONLY)

This limited warranty is extended by the manufacturer to the original purchaser and to any succeeding owner of the real property to which the low voltage room comfort control is originally affixed and applies to products purchased and retained for use within the U.S.A. and Canada.

The limited warranty period begins when the low voltage room comfort control installation is complete, verified by installer's invoice or similar document. If installation completion and start-up date cannot be verified by installer's invoice or similar document, limited warranty coverage begins six (6) months after the date of manufacture based on the low voltage room comfort control serial number.

If any part of your low voltage room comfort control fails because of a manufacturing defect within five (5) years from the date the limited warranty period begins, Warrantor will furnish without charge a new low voltage room comfort control. Any local transportation, related service labor, and diagnosis calls, are not included.

This limited warranty does not apply if the low voltage room comfort control was purchased direct (i.e. from internet websites or auctions) on an uninstalled basis. Additionally, this limited warranty will not apply unless the low voltage room comfort control is: (1) installed by a licensed or qualified HVAC technician, (2) applied and installed in accordance with the manufacturer's recommendations in its Installer's Guide, and (3) in compliance with all industry standards, national, state, and local codes.

This limited warranty does not cover your low voltage room comfort control if it is damaged while in your possession; including, but not limited to (1) damage caused by unreasonable use of the low voltage room comfort control, (2) damage from failure to properly maintain the low voltage room comfort control as set forth in the Use and Care manual, (3) damage that is not considered a manufacturing defect, such as acts of God,

malfunctions or failures resulting from fire, water, storms, lightning, earthquake, theft, riot, misuse, abuse, increased utility usage costs, or (4) performance problems due to improper selection / equipment match-up, installation, or application.

THE LIMITED WARRANTY AND LIABILITY SET FORTH HEREIN ARE IN LIEU OF ALL OTHER WARRANTIES AND LIABILITIES, WHETHER IN CONTRACT OR IN NEGLIGENCE, EXPRESSED OR IMPLIED, IN LAW OF IN FACT, INCLUDING IMPLIED WARRANTIES OF MERCHANTABILITY AND FITNESS FOR PARTICULAR USE, AND IN NO EVENT SHALL WARRANTOR BE LIABLE FOR ANY INCIDENTAL OR CONSEQUENTIAL DAMAGES.

Some states do not allow limitations on how long an implied limited warranty lasts or do not allow the exclusion or limitation of incidental or consequential damages, so the above limitation or exclusion may not apply to you. This limited warranty gives you specific legal rights, and you may also have other rights which vary from state to state.

Parts will be provided by our factory organization through an authorized service organization in your area listed in the yellow pages. If you wish further help or information concerning this limited warranty, contact:

Residential Systems
6200 Troup Highway
Tyler, TX 75707
Attention: Consumer Relations

Or visit our website: www.trane.com/residential
TW-1019-3308

Customer Assistance

If, after reading this guide, you have any questions concerning the operation of your comfort control, please call the Thermostat Customer Assistance Helpline at 1-877-880-3381.

For service, contact your local heating and cooling contractor or visit www.trane.com.

® U.S. Registered Trademark
Copyright © 2008 Trane
All Rights Reserved

22-5207-04

69-1791—05 M.S. Rev. 11-08

Printed in Mexico



TRANE®

Trane
Troup Highway
Tyler, TX 75711-9010